



FOCUS TORCHES

PROPANE

LIQUID

GAS

AL-18-SM SERIES LIQUID FOCUS TORCH & AREA LIGHT



SPECIFICATIONS

CONSTRUCTION: Spun copper hat, snuff cap with cast brass adjustable hub; matching extruded copper stanchion. Hammered surface on hat available on -HH models

FUEL CAPACITY: 14 ounces in vertical position; approximately 7 hours burn time

WICK: Long lasting 1/4" round braided fiberglass

LAMP SUPPLIED: 20w T4 Halogen 10,000 hours average rating (20w max.)

LAMP OPTIONS: We recommend 10,000 hours average rating 20w Xenon (-X), 3w 50,000 hours average rating OMNI-3 (-LED3)

SOCKET: Single contact bayonet, brass nickel plated lamp socket screw shell (Ba15s) with 200°C silicone lead wires

WIRING: Black 3 foot 18/2 zip cord from base of fixture (12v only)

For 25 foot 16/2 fixture lead wire add -25F to catalog number.
120v standard wiring

CONNECTION: FA-05 Quick Connector (not supplied) from fixture to main cable (12/2, 10/2 or 8/2 only)

MOUNTING: Angle cut stanchion; -DM (deck mount) models have FA-03 black 9" ABS stake, tapped 1/2" NPS

FINISH: Unfinished copper

Optional finishes available in Acid Rust (-CAR), Acid Verde (-CAV), Black Acid Treatment (-BAT)



DETAIL OF
HAMMERED HAT
MODEL (-HH)

AL-18-SM-AH-COP

ORDERING INFORMATION

CATALOG NO.	DESCRIPTION	LAMP	SHIP WEIGHT
AL-18-SM-AH-COP	Copper FOCUS Torch Light	20w T4 Halogen	5.0 lbs.
AL-18-SM-AH-BB-COP	Copper FOCUS Torch Light, Brass Bamboo Stem	20w T4 Halogen	8.0 lbs.
AL-18-SM-AH-SB-COP	Copper FOCUS Torch Light, Simulated UV Stabilized PVC Bamboo Stem	20w T4 Halogen	8.0 lbs.
AL-18-SM-AH-SBD-COP	Copper FOCUS Torch Light, Deluxe Painted Simulated UV Stabilized PVC Bamboo Stem	20w T4 Halogen	8.0 lbs.
AL-18-SMDM-AH-COP	Copper FOCUS Torch Light	20w T4 Halogen	5.0 lbs.
AL-18-SMDM-AH-BB-COP	Copper FOCUS Torch Light, Brass Bamboo Stem	20w T4 Halogen	8.0 lbs.
AL-18-SMDM-AH-SB-COP	Copper FOCUS Torch Light, Simulated UV Stabilized PVC Bamboo Stem	20w T4 Halogen	8.0 lbs.
AL-18-SMDM-AH-SBD-COP	Copper FOCUS Torch Light, Deluxe Painted Simulated UV Stabilized PVC Bamboo Stem	20w T4 Halogen	8.0 lbs.
AL-18-SM-HH-AH-COP	Copper Hammered FOCUS Torch Light	20w T4 Halogen	5.0 lbs.
AL-18-SM-HH-AH-BB-COP	Copper Hammered FOCUS Torch, Brass Bamboo Stem	20w T4 Halogen	8.0 lbs.
AL-18-SM-HH-AH-SB-COP	Copper Hammered FOCUS Torch, Simulated UV Stabilized UV Stabilized PVC Bamboo Stem	20w T4 Halogen	8.0 lbs.
AL-18-SM-HH-AH-SBD-COP	Copper Hammered FOCUS Torch, Deluxe Painted Simulated UV Stabilized PVC Bamboo Stem	20w T4 Halogen	8.0 lbs.
AL-18-SMDM-HH-AH-COP	Copper Hammered FOCUS Torch Light	20w T4 Halogen	5.0 lbs.
AL-18-SMDM-HH-AH-BB-COP	Copper Hammered FOCUS Torch, Brass Bamboo Stem	20w T4 Halogen	8.0 lbs.
AL-18-SMDM-HH-AH-SB-COP	Copper Hammered FOCUS Torch, Simulated UV Stabilized PVC Bamboo Stem	20w T4 Halogen	8.0 lbs.
AL-18-SMDM-HH-AH-SBD-COP	Copper Hammered FOCUS Torch, Deluxe Painted Simulated UV Stabilized PVC Bamboo Stem	20w T4 Halogen	8.0 lbs.

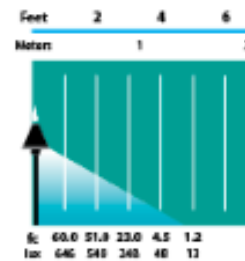

AL-18-SM
Half Spread Photometrics
12ft (3.7m) diameter

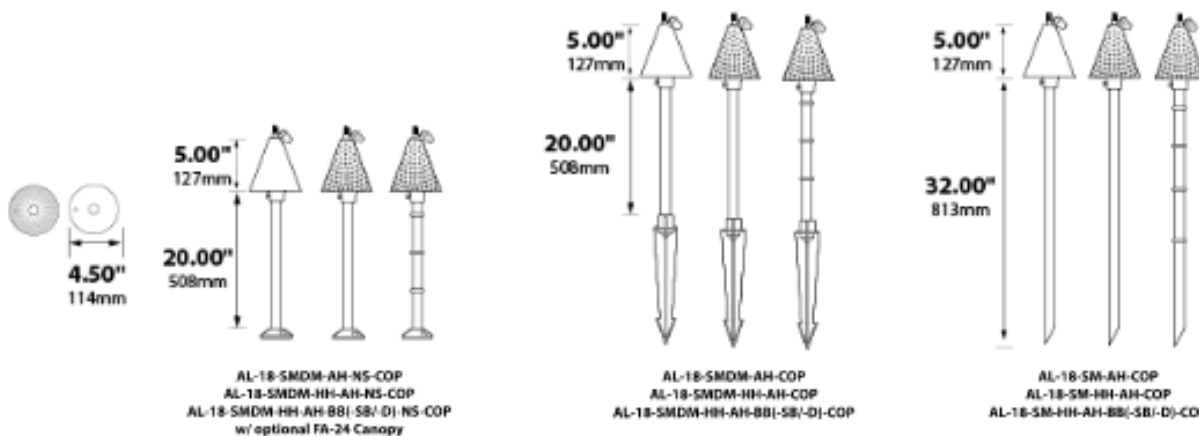

FOCUS TORCHES



www.focusindustries.com

MADE IN AMERICA



AL-18-SM SERIES LIQUID FOCUS TORCH & AREA LIGHT

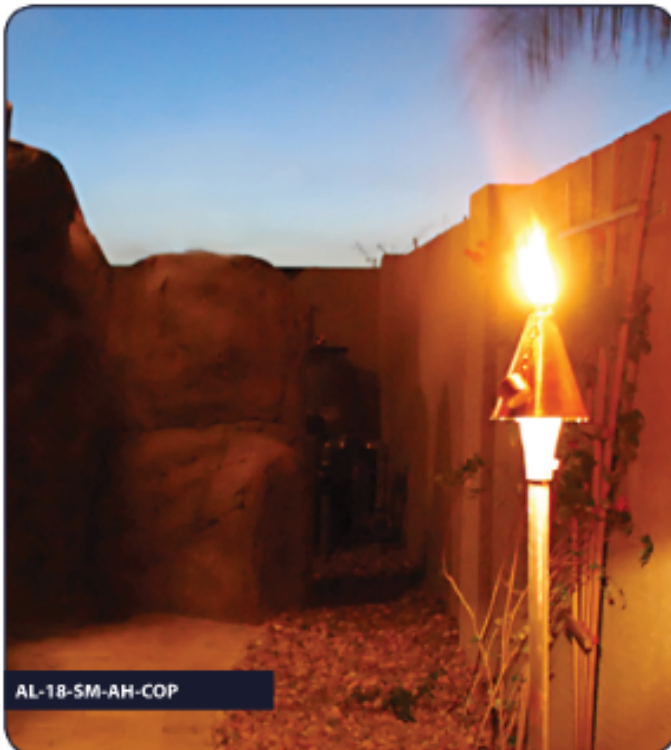

MADE IN AMERICA www.focusindustries.com



FOCUS TORCHES



AL-18-LG SERIES LIQUID FOCUS TORCH & AREA LIGHT



SPECIFICATIONS

CONSTRUCTION: Spun copper hat, snuff cap with cast brass adjustable hub; matching extruded copper stanchion. Hammered surface on hat available on -HH models

FUEL CAPACITY: 20 ounces in vertical position; approximately 10 hours burn time

WICK: Long lasting 3/4" round braided fiberglass

LAMP SUPPLIED: 20w T4 S.C. Halogen 10,000 hours average rating (20w max.)

LAMP OPTIONS: We recommend 10,000 hours average rating 20w Xenon (-X), or 3w 50,000 hours average rating OMNI-3 LED (-LED3)

SOCKET: Single contact bayonet, brass nickel plated lamp socket screw shell (Ba15s) with 200°C silicone lead wires

WIRING: Black 3 foot 18/2 zip cord from base of fixture (12v only)

For 25 foot 16/2 fixture lead wire add -25F to catalog number.

120v standard wiring

CONNECTION: FA-05 Quick Connector (not supplied) from fixture to main cable (1/2", 10/2 or 8/2 only)

MOUNTING: Angle cut stanchion

FINISH: Unfinished copper

Optional finishes available in Acid Rust (-CAR), Acid Verde (-CAV), Black Acid Treatment (-BAT)



AL-18-LG-AH-COP



AL-18-LG-HH-AH-SB-CAR

ORDERING INFORMATION

CATALOG NO.	DESCRIPTION	LAMP	SHIP WEIGHT
AL-18-LG-AH-COP	Large Copper FOCUS Torch Light	20w T4 Halogen	6.0 lbs.
AL-18-LG-AH-BB-COP	Large Copper FOCUS Torch Light, Brass Bamboo Stem	20w T4 Halogen	9.0 lbs.
AL-18-LG-AH-SB-COP	Large Copper FOCUS Torch Light,	20w T4 Halogen	7.0 lbs.
	Simulated UV Stabilized PVC Bamboo Stem		
AL-18-LG-AH-SBD-COP	Large Copper FOCUS Torch Light,	20w T4 Halogen	7.0 lbs.
	Deluxe Painted Simulated UV Stabilized PVC Bamboo Stem		
AL-18-LG-HH-AH-COP	Large Copper Hammered FOCUS Torch Light	20w T4 Halogen	6.0 lbs.
AL-18-LG-HH-AH-BB-COP	Large Copper Hammered FOCUS Torch Light,	20w T4 Halogen	9.0 lbs.
	Brass Bamboo Stem		
AL-18-LG-HH-AH-SB-COP	Large Copper Hammered FOCUS Torch Light,	20w T4 Halogen	7.0 lbs.
	Simulated UV Stabilized PVC Bamboo Stem		
AL-18-LG-HH-AH-SBD-COP	Large Copper Hammered FOCUS Torch Light,	20w T4 Halogen	7.0 lbs.

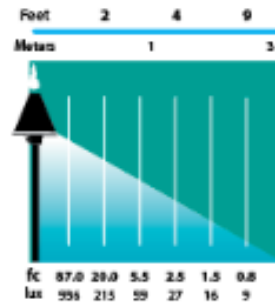

AL-18-LG

Half Spread Photometrics
18ft (5.4m) diameter

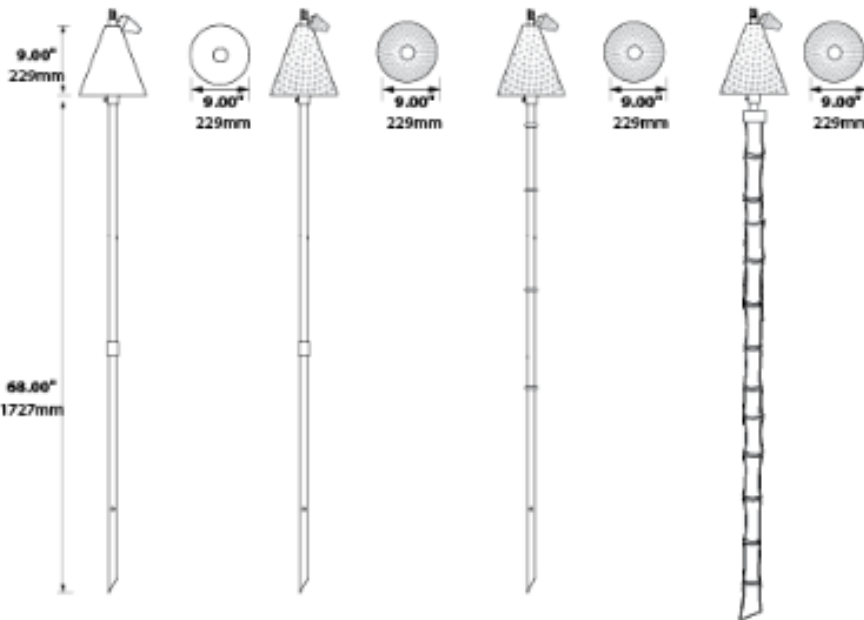

AL-18-LG-AH-COP

AL-18-LG-HH-AH-COP

AL-18-LG-HH-AH-BB-COP

AL-18-LG-HH-AH-SB-COP



FOCUS TORCHES



www.focusindustries.com MADE IN AMERICA



AL-18-LG SERIES LIQUID FOCUS TORCH & AREA LIGHT



AL-18-LG-AH-COP



AL-18-LG-HH-AH-BB-CAR



AL-18-LG-HH-AH-COP



AL-18-LG-AH-COP



AL-18-LG-AH-COP



MADE IN AMERICA www.focusindustries.com



FOCUS TORCHES



AL-18-LG-NG/-P NATURAL GAS & PROPANE TORCH



SPECIFICATIONS

CONSTRUCTION: Spun copper, 18 ga. (.043 thickness), Cast brass pipe adapter & internal parts. Stainless Steel perforated flame screen. Hammered surface available on -HH models

GAS USAGE AL-18LG-NG (Natural Gas): Uses 22,500 BTU/Hour
normal inlet pressure 7" water column

GAS USAGE AL-18LG-P (Propane Gas): Uses 17,000 BTU/Hour
normal inlet pressure 11" water column

INSTALLATION: 1" cast brass adapter has standard female NPT pipe threads for connection to 1" steel pipe (supplied by others). Always check with local codes prior to installation.

VALVE: 1" brass shut-off valve required (supplied by others)

IGNITION: Manual ignition with extended lighter

FINISH: Unfinished copper

Optional finishes available in Acid Rust (-CAR), Acid Verde (-CAV), Black Acid Treatment (-BAT)

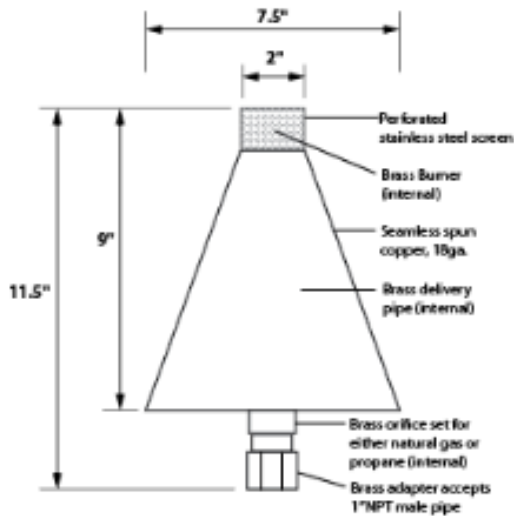

TWO HAT STYLES



Smooth Hat (Standard)



Hammered Hat (-HH)

ORDERING INFORMATION

CATALOG NO.	DESCRIPTION	SHIP WEIGHT
AL-18-LGNG-COP	Large Copper Natural Gas Fed FOCUS Torch	5.0 lbs.
AL-18-LGP-COP	Large Copper Propane Fed FOCUS Torch	5.0 lbs.
AL-18-LGNGHH-COP	Large Hammered Copper Natural Gas Fed FOCUS Torch	5.0 lbs.
AL-18-LGPHH-COP	Large Hammered Copper Propane Fed FOCUS Torch	5.0 lbs.
FA-SB-ABS6P:	Simulated 6' PVC deluxe painted bamboo sleeve only for natural gas or propane models	
FA-SB-ABS6U:	Simulated 6' PVC unfinished bamboo sleeve only for natural gas or propane models	

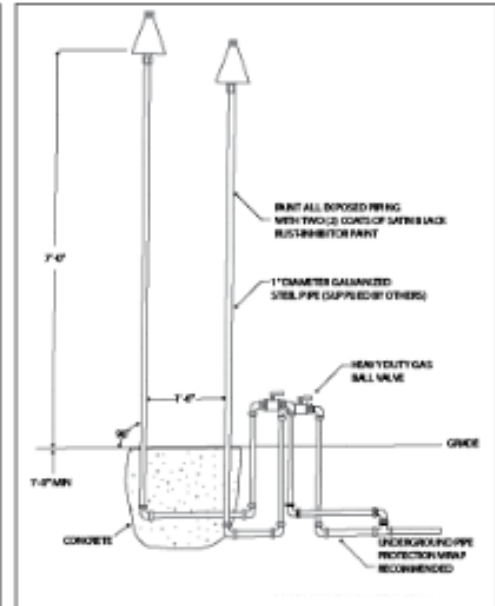
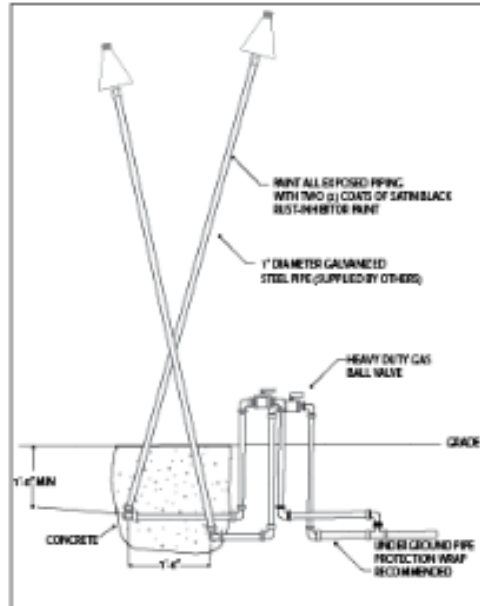
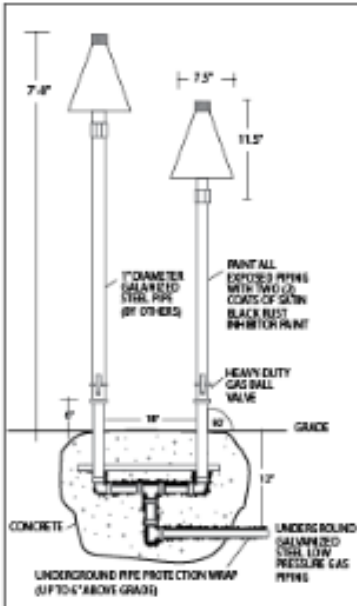

Please consult a licensed plumber for gas layout and installation



FOCUS TORCHES



www.focusindustries.com

MADE IN AMERICA



AL-18-LG-NG/-P NATURAL GAS & PROPANE TORCH



AL-18-LG-NG-HH-CAR



AL-18-LG-P-HH-CAR



AL-18-LG-P-HH-COP



MADE IN AMERICA www.focusindustries.com



FOCUS TORCHES



AL-18-CY-NG/-P NATURAL GAS & PROPANE TORCHES



SPECIFICATIONS

CONSTRUCTION: Stainless steel, 18 ga. (.043 thickness), Cast brass pipe adapter & internal parts. Stainless Steel perforated flame screen.

GAS USAGE AL-18CYNG-SS (NATURAL GAS): Uses 22,500 BTU/Hour
normal inlet pressure 7" water column

GAS USAGE AL-18CYP-SS (PROPANE GAS): Uses 17,000 BTU/Hour
normal inlet pressure 11" water column

INSTALLATION: 1" cast brass adapter has standard female NPT pipe threads for connection to 1" steel pipe (supplied by others)

VALVE: 1" brass shut-off valve required (supplied by others)

IGNITION: Manual ignition with extended lighter

FINISH: Unfinished Stainless Steel

ORDERING INFORMATION

CATALOG NO.	DESCRIPTION	SHIP WEIGHT
AL-18-CY-XXX-NG-SS	Laser Cut Stainless Steel Natural Gas Fed Torch	5.0 lbs.
AL-18-CY-XXX-P-SS	Laser Cut Stainless Steel PropaneFed Torch	5.0 lbs.
AL-18-CY-XXX-SS	Laser Cut Stainless Steel Replacement Sleeve Only	2.0 lbs.

FA-SB-ABS6P: 6' UV Stabilized PVC deluxe painted bamboo sleeve (inside diameter 1.330") only for natural gas or propane models

FA-SB-ABS6U: 6' UV Stabilized PVC unfinished bamboo sleeve (inside diameter 1.330") only for natural gas or propane models

Sandstone-001

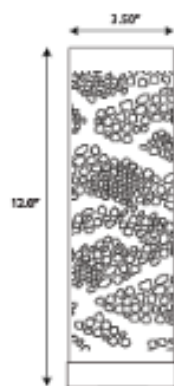

Heliconia-002



Circles-003

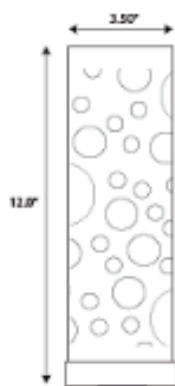

Palm-004

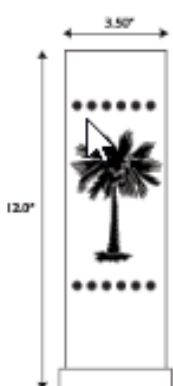

Wave-005



Bamboo-006



Bird Of Paradise-007



Hibiscus-008

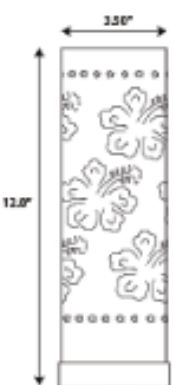

Plumeria-009



Banana Leaf-010



FOCUS TORCHES



www.focusindustries.com

MADE IN AMERICA



AL-18-CY-NG/-P NATURAL GAS & PROPANE TORCHES



AL-18-CY-003-NG-SS



AL-18-CY-001-NG-SS



AL-18-CY-008-NG-SS



Sandstone-001



Circles-003



Bamboo-006



Hibiscus-008



Plumeria-009



MADE IN AMERICA www.focusindustries.com



FOCUS TORCHES





FOCUS TORCHES



www.focusindustries.com MADE IN AMERICA





MADE IN AMERICA www.focusindustries.com



FOCUS TORCHES



FOUR FINISHES AVAILABLE • For All AL-18-LG & AL-18-SM Models



Unfinished



Acid Rust (-CAR)



Acid Verde (-CAV)



Black Acid (-BAT)

HAT OPTIONS



AL-18-LG & AL-18-SM MODELS

Hammered Smooth

STEM OPTIONS



Simulated bamboo inside diameter 1.330"

FOCUS SKIRT

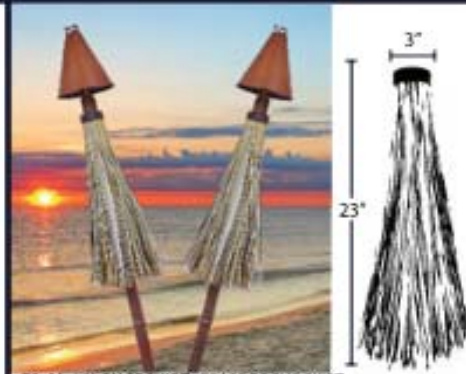

FA-AL-18LGNGPSKIRT: GRASS FOCUS SKIRT. 1.7" ID. FOR AL-18-LG NG/P GAS FOCUS SERIES

MOUNTING ACCESSORIES (AL-18-SM ONLY)

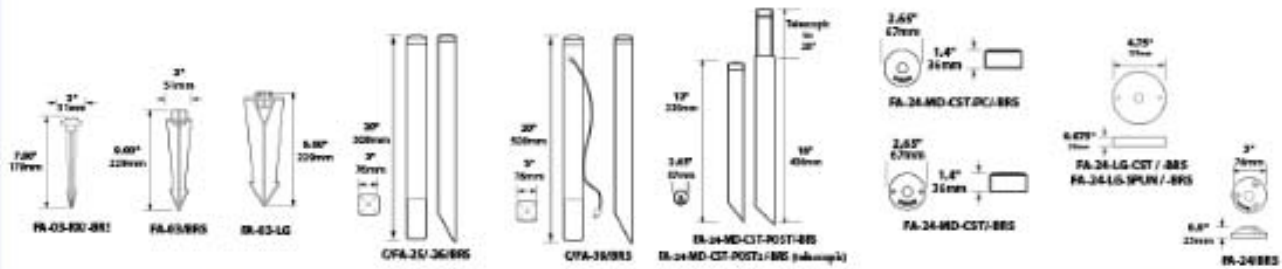

★ FOCUS INDUSTRIES®, INC.

WORLD HEADQUARTERS

25301 Commercentre Drive, Lake Forest, CA 92630
 Phone: (949) 830-1350 • Toll free: (888) 882-1350
www.focusindustries.com
 E-mail: focus@focusindustries.com

REGIONAL DISTRIBUTION CENTERS

■ PENNSYLVANIA 11550 Roosevelt Blvd., Unit G-1, Philadelphia, PA 19116 Ph (215) 677-6870 • Toll Free (800) 468-0801 • Fax (215) 677-1261 • Amisand@associatedmarketing.net

Focus Industries® strives to continually improve its product line. We reserve the right to modify product from that pictured. Not responsible for typographical or misprint errors.

FSA-PM-02006 052016

© 2016 Focus Industries,® Inc. • All Rights Reserved.

